

REV.	ECN NO.	DESCRIPTION	DATE	DESIGN
A				

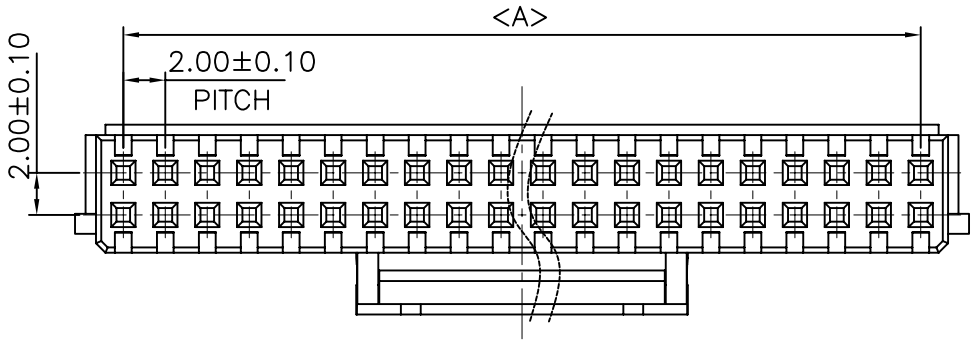

Specifications:
 Current rating:3A AC/DC.
 Voltage rating:250V AC/DC
 Temperature range:-40°C~+105°C.
 Contact resistance:30MΩ Max.
 Insulation resistance:1000MΩ Min.
 Withstanding voltage: 1000V AC/minute.
 Material:PA66.UL94V-0.

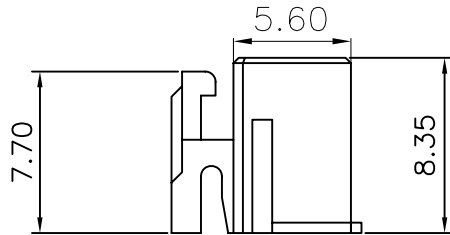
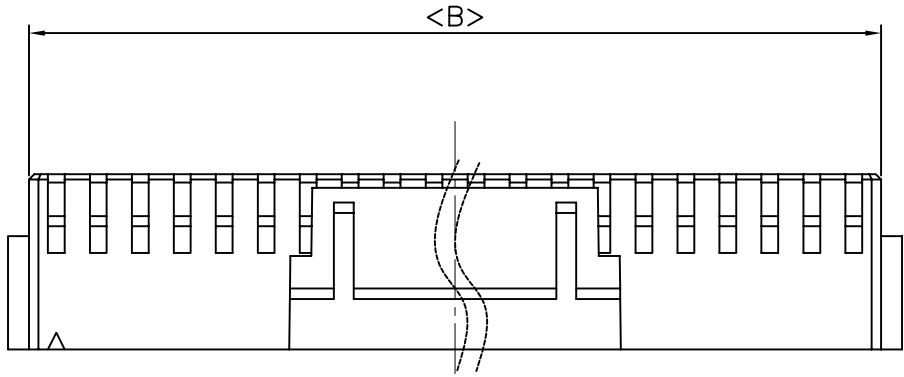

PART NO.	Dimensions		
	A	B	C
A2008H-2X02P	2.00	4.60	5.60
A2008H-2X03P	4.00	6.60	7.60
A2008H-2X04P	6.00	8.60	9.60
A2008H-2X05P	8.00	10.60	11.60
A2008H-2X06P	10.00	12.60	13.60
A2008H-2X07P	12.00	14.60	15.60
A2008H-2X08P	14.00	16.60	17.60
A2008H-2X09P	16.00	18.60	19.60
A2008H-2X10P	18.00	20.60	21.60
A2008H-2X11P	20.00	22.60	23.60
A2008H-2X12P	22.00	24.60	25.60
A2008H-2X13P	24.00	26.60	27.60
A2008H-2X14P	26.00	28.60	29.60
A2008H-2X15P	28.00	30.60	31.60
A2008H-2X16P	30.00	32.60	33.60
A2008H-2X17P	32.00	34.60	35.60
A2008H-2X18P	34.00	36.60	37.60
A2008H-2X19P	36.00	38.60	39.60
A2008H-2X20P	38.00	40.60	41.60

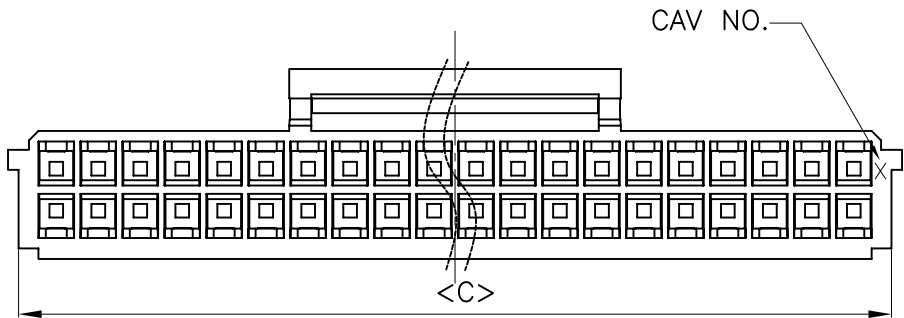

DIM	TOL	DIM	TOL
X.	/	X*	/
X.X	0.25	X.X*	
X.XX	0.15	X.XX*	
X.XXX	0.10	X.XXX*	/

CNJM Joint More Precision electronics Co.,Ltd.

DRAW NO.	DATE	P/N NO.	DRAW NAME:
DESIGN: 陈雪峰	2017.06.03	A2008H-2XNP	2.0mm pitch housing
CHECK: 杨焯			
REVIEW:		REV.A/1 SCALE 1:1	UNIT: mm SHEET 1 OF 1

REV.	ECN NO.	DESCRIPTION	DATE	DESIGN
A				

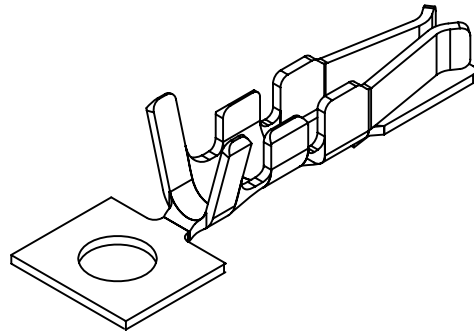
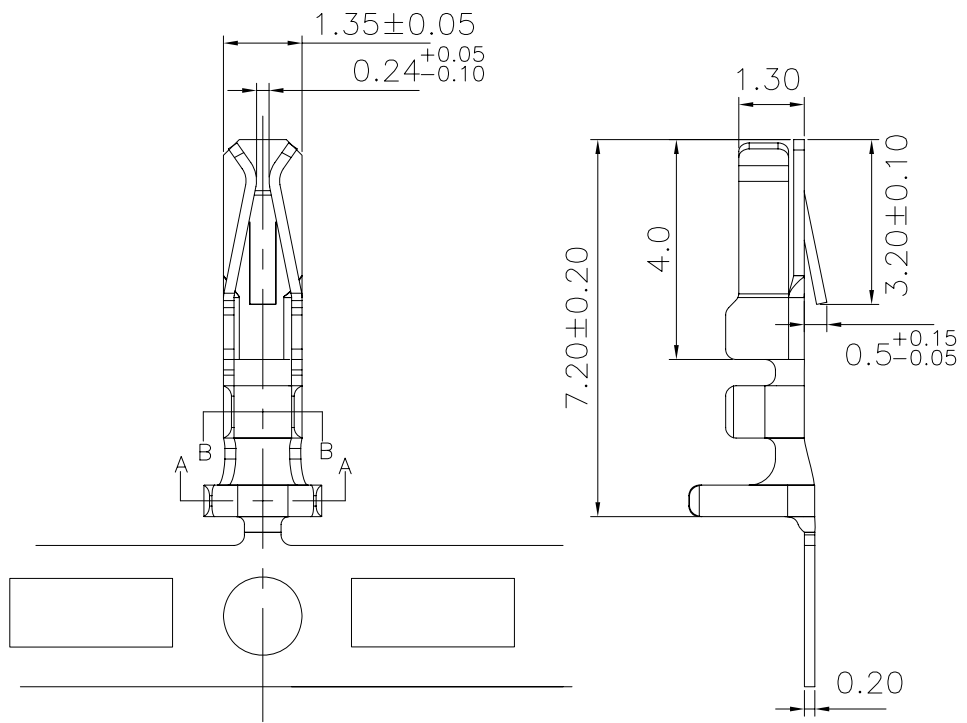

NOTES:
 1.FLASH: 0.05MAX;WARPAGE: 0.10MAX.
 2.RETENTION FORCE: 1.5kgf MIN.

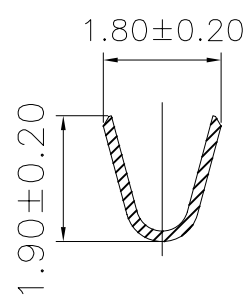

SECTION: (A-A)

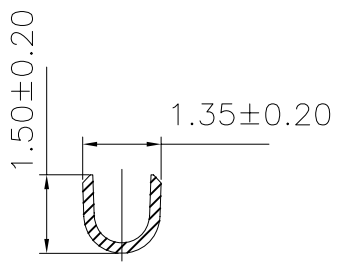

SECTION: (B-B)

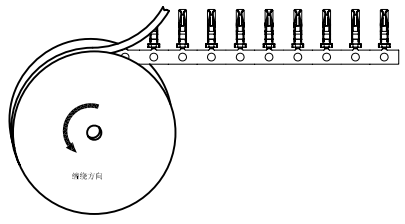

电镀后的收料方向
(打线开口朝外)

CNJM Joint More Precision electronics Co.,Ltd.

Part NO.	Wire range	Insulation O.D.	Materials	Finish	Qty/reel
A2008-TPE	AWG#22-28	1.5mm(max)	Phosphor Bronze	Tin-plated	12000PCS
A2008-TP	AWG#22-28	1.5mm(max)	Phosphor Bronze	Tin-plated	12000PCS

DIM	TOL	DIM	TOL
X.	/	X*	/
X.X	0.25	X.X*	
X.XX	0.15	X.XX*	
X.XXX	0.10	X.XXX*	/

DRAW NO.	DATE	P/N NO:	DRAW NAME:
DESIGN: 陈雪峰	2017.06.03	A2008-XXX	2.0mm pitch terminal
CHECK: 杨焯			
REVIEW:		REV.A/1	SCALE 1:1

UNIT: mm SHEET: 1 OF 1

REV.	ECN NO.	DESCRIPTION	DATE	DESIGN
A				

NOTES:
 CURRENT RATING:3A AC/DC.
 VOLTAGE RATING:250V AC/DC
 TEMPERATURE RANGE:-40°C~+105°C.
 CONTACT RESISTANCE:30MΩ Max.
 INSULATION RESISTANCE:1000MΩ Min.
 WITHSTANDING VOLTAGE: 1000V AC/MINUTE.
 MATERIAL:PA46.

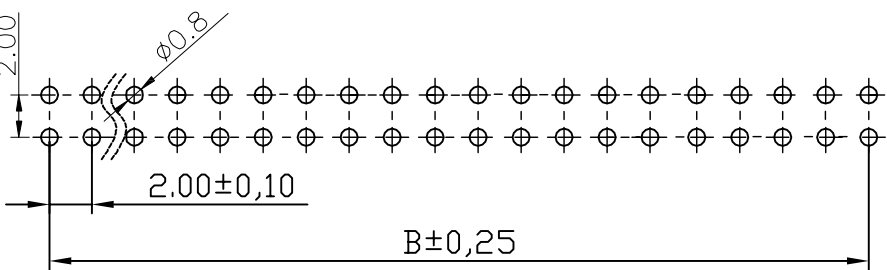
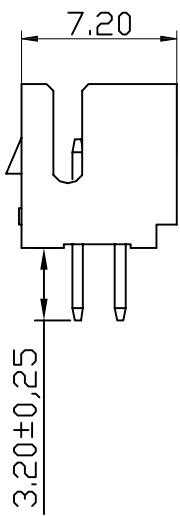
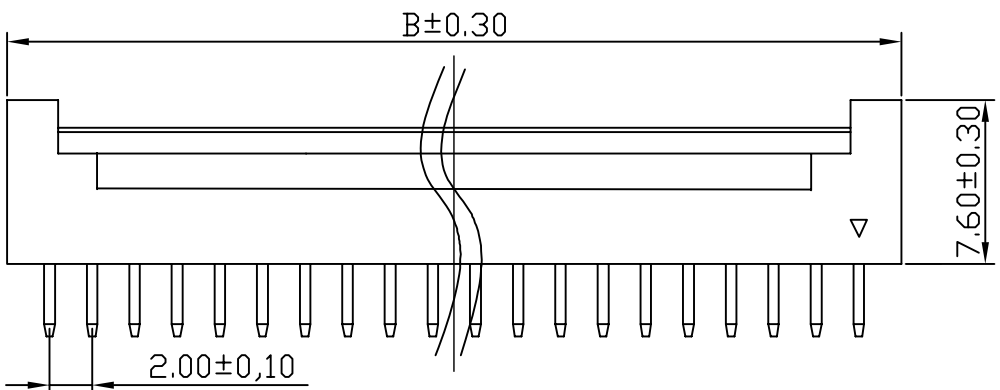
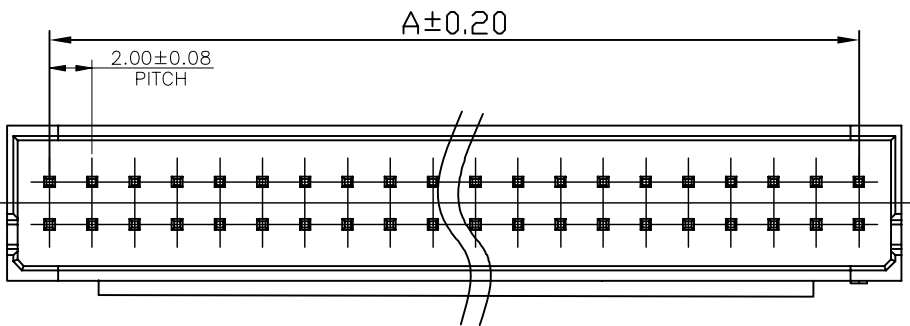

PART NO.	Dimensions	
	A	B
A2008WR-2X04P	6.00	10.00
A2008WR-2X05P	8.00	12.00
A2008WR-2X06P	10.00	14.00
A2008WR-2X07P	12.00	16.00
A2008WR-2X08P	14.00	18.00
A2008WR-2X09P	16.00	20.00
A2008WR-2X10P	18.00	22.00
A2008WR-2X11P	20.00	24.00
A2008WR-2X12P	22.00	26.00
A2008WR-2X13P	24.00	28.00
A2008WR-2X14P	26.00	30.00
A2008WR-2X15P	28.00	32.00
A2008WR-2X16P	30.00	34.00
A2008WR-2X17P	32.00	36.00
A2008WR-2X18P	34.00	38.00
A2008WR-2X19P	36.00	40.00
A2008WR-2X20P	38.00	42.00
A2008WR-2X21P	40.00	44.00
A2008WR-2X22P	42.00	46.00

CNJM Joint More Precision electronics Co.,Ltd.

DRAW NO.	DATE	P/N NO.	DRAW NAME:
DESIGN: 陈雪峰	2017.06.03	A2008WV-2XNP	PHB2.0mm pitch wafer
CHECK: 杨焯			
REVIEW:		REV. A/1	SCALE 1:1
		UNIT: mm	SHEET 1 OF 1

DIM	TOL	DIM	TOL
X.	/	X*	/
X.X	0.25	X.X*	/
X.XX	0.15	X.XX*	/
X.XXX	0.10	X.XXX*	/

REV.	ECN NO.	DESCRIPTION	DATE	DESIGN
A				

NOTES:

CURRENT RATING:3A AC/DC.
 VOLTAGE RATING:250V AC/DC
 TEMPERATURE RANGE:-40°C~+105°C.
 CONTACT RESISTANCE:30MΩ Max.
 INSULATION RESISTANCE:1000MΩ Min.
 WITHSTANDING VOLTAGE: 1000V AC/MINUTE.
 MATERIAL:PA46.

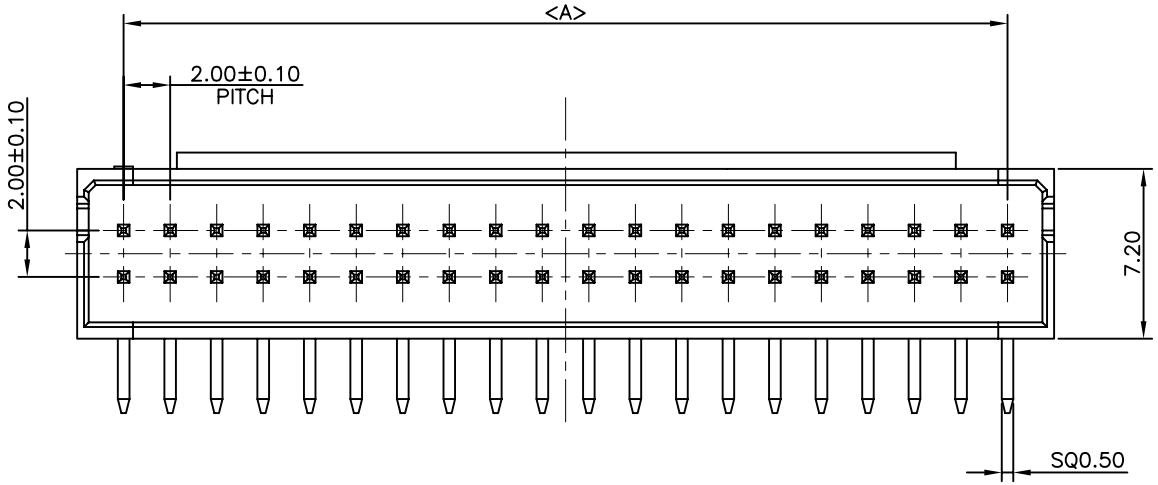
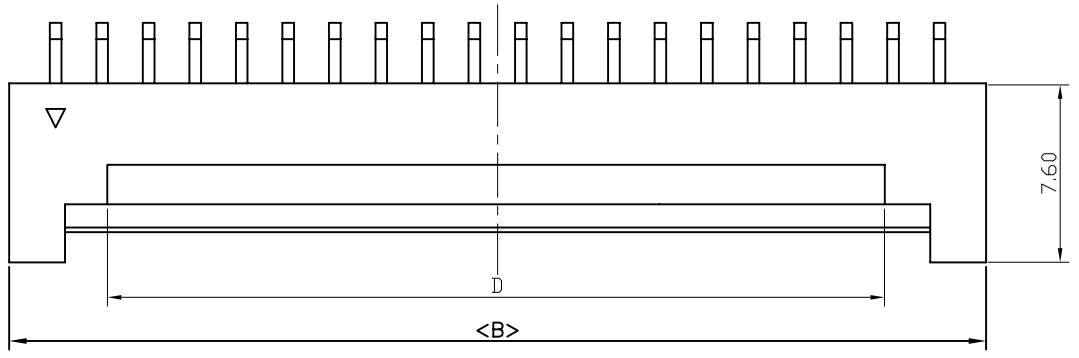

Recommended P.C.B Layout(Top Side)
 P.C.B Thickness = 1.60mm
 (Tolerance=±0.05)

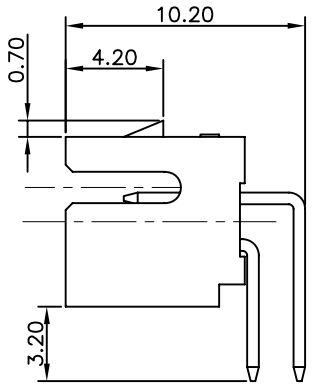
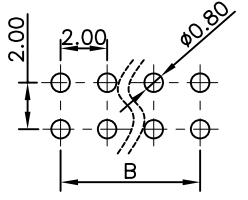

PART NO.	Dimensions	
	A	B
A2008WR-2X04P	6.00	10.00
A2008WR-2X05P	8.00	12.00
A2008WR-2X06P	10.00	14.00
A2008WR-2X07P	12.00	16.00
A2008WR-2X08P	14.00	18.00
A2008WR-2X09P	16.00	20.00
A2008WR-2X10P	18.00	22.00
A2008WR-2X11P	20.00	24.00
A2008WR-2X12P	22.00	26.00
A2008WR-2X13P	24.00	28.00
A2008WR-2X14P	26.00	30.00
A2008WR-2X15P	28.00	32.00
A2008WR-2X16P	30.00	34.00
A2008WR-2X17P	32.00	36.00
A2008WR-2X18P	34.00	38.00
A2008WR-2X19P	36.00	40.00
A2008WR-2X20P	38.00	42.00
A2008WR-2X21P	40.00	44.00
A2008WR-2X22P	42.00	46.00

DIM	TOL	DIM	TOL
X.	/	X*	/
X.X	0.25	X.X*	
X.XX	0.15	X.XX*	
X.XXX	0.10	X.XXX*	/

CNJM Joint More Precision electronics Co.,Ltd.

DRAW NO.	DATE	P/N NO:	DRAW NAME:
DESIGN: 陈雪峰	2017.06.03	A2008WR-2XNP	PHB2.0mm pitch wafer
CHECK: 杨焯			
REVIEW:		REV. A/1	SCALE 1:1
		UNIT: mm	SHEET 1 OF 1