

REV.	ECN NO.	DESCRIPTION	DATE	DESIGN
A				

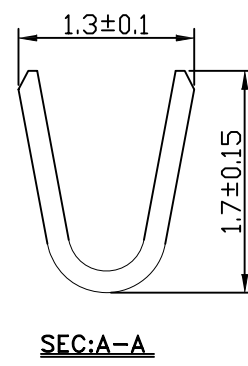
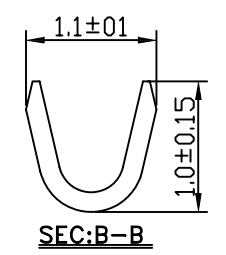
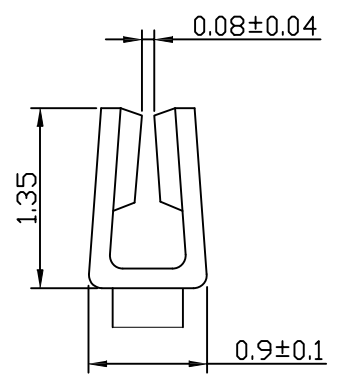
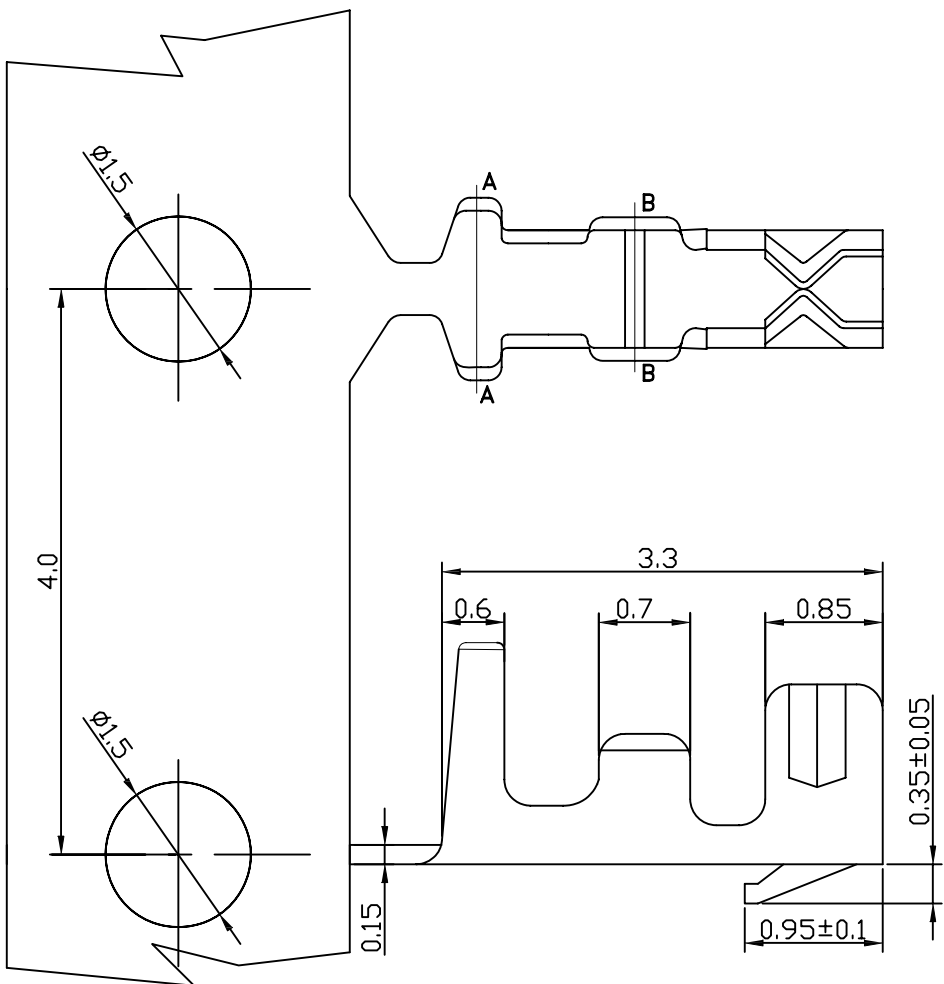

CNJM Joint More Precision electronics Co.,Ltd.

A1251-TPE	AWG #28-#32	1.00mm(max)	Phosphor Bronze	Tin over Nickel	15000PCS
Part NO.	Wire Range	Insulation O.D.	Material	Finish	Qty/reel

DIM	TOL	DIM	TOL
X.	/	X*	/
X.X	0.25	X.X*	
X.XX	0.15	X.XX*	
X.XXX	0.10	X.XXX*	/

DRAW NO.	DATE	P/N NO.	DRAW NAME:
DESIGN: 陈雪峰	2017.06.03	A1251-TPE	1.25mm pitch terminal
CHECK: 杨焯			
REVIEW:		REV. A/1	SCALE 1:1
		UNIT: mm	SHEET: 1 OF 1

REV.	ECN NO.	DESCRIPTION	DATE	DESIGN
A				

Specifications:
 Current rating:1A AC/DC.
 Voltage rating:125V AC/DC
 Temperature range:-40°C~+105°C.
 Contact resistance:20MΩ Max.
 Insulation resistance:100MΩ Min.
 Withstanding voltage: 500V AC/minute.
 Material:PA46.UL94V-0.

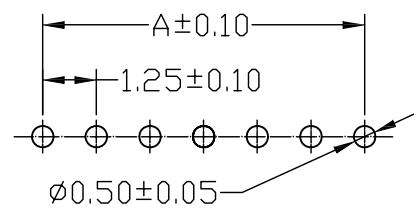
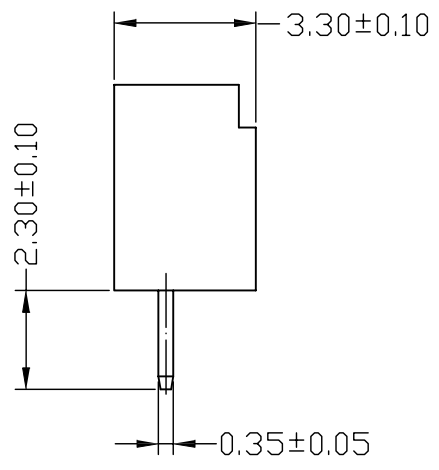
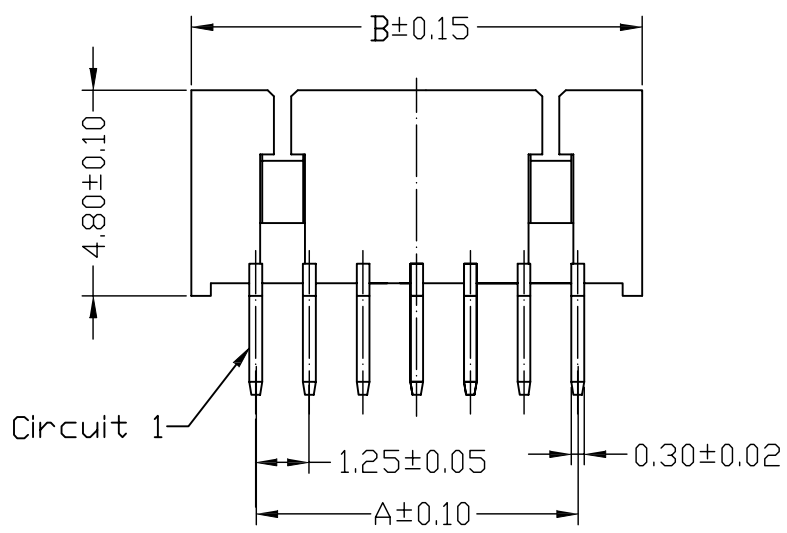
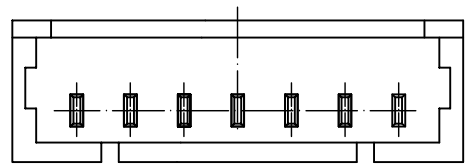
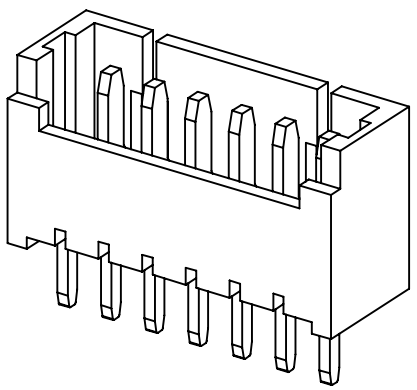

P.C.B LAYOUT

PART NO.	Dimensions	
	A	B
A1251WV-02P	1.25	4.25
A1251WV-03P	2.50	5.50
A1251WV-04P	3.75	6.75
A1251WV-05P	5.00	8.00
A1251WV-06P	6.25	9.25
A1251WV-07P	7.50	10.50
A1251WV-08P	8.75	11.75
A1251WV-09P	10.00	13.00
A1251WV-10P	11.25	14.25
A1251WV-11P	12.50	15.50
A1251WV-12P	13.75	16.75
A1251WV-13P	15.00	18.00
A1251WV-14P	16.25	19.25
A1251WV-15P	17.50	20.50
A1251WV-16P	18.75	21.75

CNJM Joint More Precision electronics Co.,Ltd.

DRAW NO.	DATE	P/N NO.	DRAW NAME:
DESIGN: 陈雪峰	2017.06.03	A1251WV-NP	1.25mm pitch wafwr
CHECK: 杨焯			
REVIEW:		REV. A/1	SCALE 1:1

DIM	TOL	DIM	TOL
X.	/	X*	/
X.X	0.25	X.X*	
X.XX	0.15	X.XX*	
X.XXX	0.10	X.XXX*	/

UNIT: mm SHEET: 1 OF 1

REV.	ECN NO.	DESCRIPTION	DATE	DESIGN
A				

Specifications:
 Current rating:1A AC/DC.
 Voltage rating:125V AC/DC
 Temperature range:-40°C~+105°C.
 Contact resistance:20MΩ Max.
 Insulation resistance:100MΩ Min.
 Withstanding voltage: 500V AC/minute.
 Material:PA46.UL94V-0.

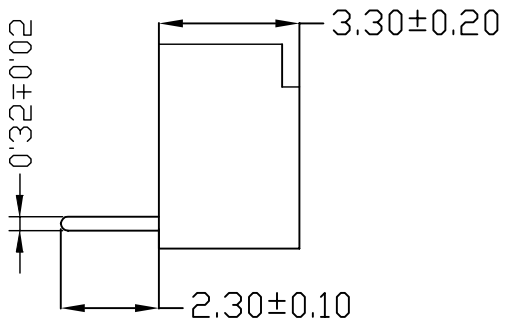
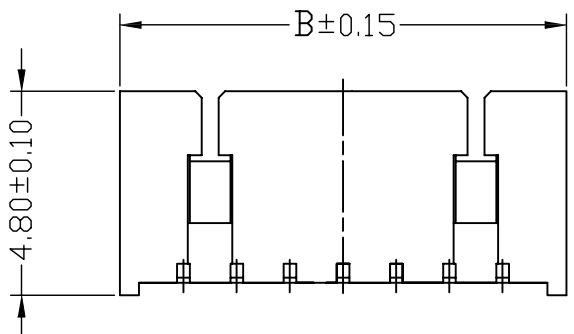
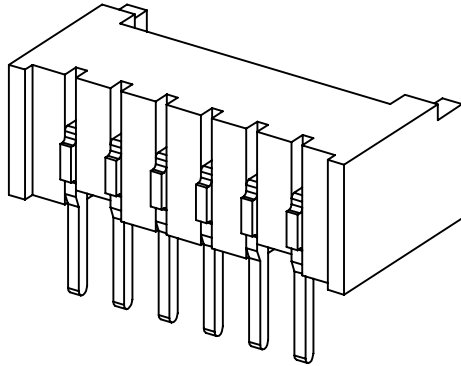
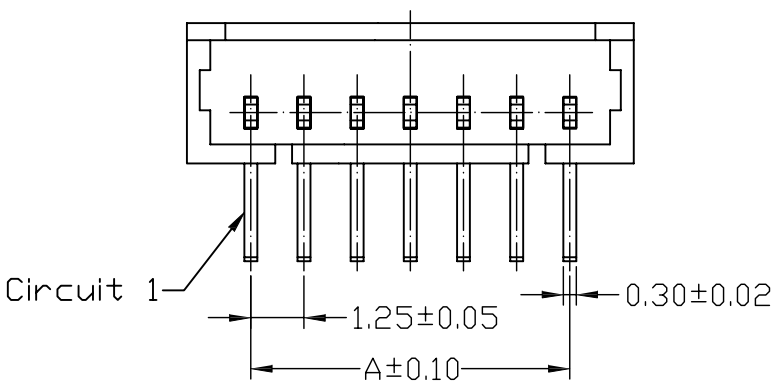

PART NO.	Dimensions	
	A	B
A1251WR-02P	1.25	4.25
A1251WR-03P	2.50	5.50
A1251WR-04P	3.75	6.75
A1251WR-05P	5.00	8.00
A1251WR-06P	6.25	9.25
A1251WR-07P	7.50	10.50
A1251WR-08P	8.75	11.75
A1251WR-09P	10.00	13.00
A1251WR-10P	11.25	14.25
A1251WR-11P	12.50	15.50
A1251WR-12P	13.75	16.75
A1251WR-13P	15.00	18.00
A1251WR-14P	16.25	19.25
A1251WR-15P	17.50	20.50
A1251WR-16P	18.75	21.75

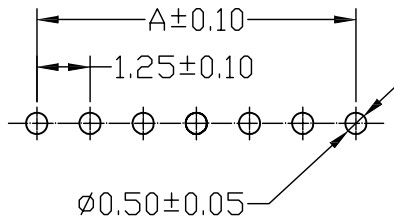

P.C.B LAYOUT

DIM	TOL	DIM	TOL
X.	/	X*	/
X.X	0.25	X.X*	
X.XX	0.15	X.XX*	
X.XXX	0.10	X.XXX*	/

CNJM Joint More Precision electronics Co.,Ltd.

DRAW NO.	DATE	P/N NO.	DRAW NAME:
DESIGN: 陈雪峰	2017.06.03	A1251WR-NP	1.25mm pitch wafer
CHECK: 杨焯			
REVIEW:		REV. A/1	SCALE 1:1
		UNIT: mm	SHEET: 1 OF 1